



Operating instructions

(Translation of the original operating instructions)

Fan 0,55 - 11 kW

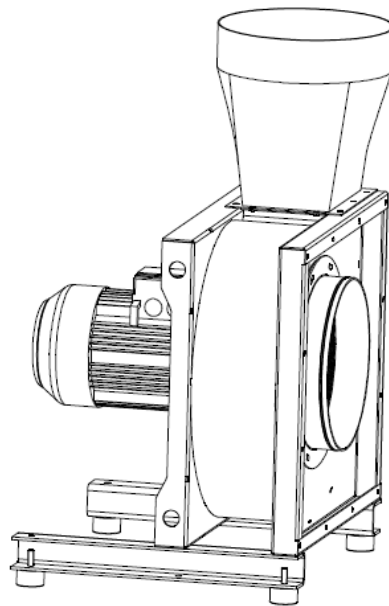
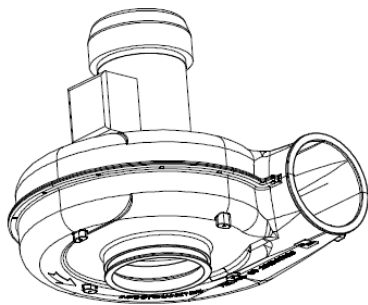



Table of contents

1. General	3
2. Description of the system elements	4
2.1. Illustration of the system elements	4
2.2. Intended use	4
2.3. Residual risk	5
3. Safety instructions	6
3.1. Definition of the hazard symbols	6
3.2. General safety instructions	6
4. Storage, transport and installation of the device	7
5. Commissioning	7
5.1. Connecting the suction line and exhaust air line	8
5.2. Electrical connection	8
6. Maintenance	9
6.1. Reset to maintenance state	9
7. Dismantling / Disposal	9
8. Diagnostics and troubleshooting	10
9. Technical data	11
10. EC declaration of conformity	12
11. Maintenance intervals	13
11.1. General maintenance	13
11.1.1. Visual inspection of the device	13
11.1.2. Electrical test of the electrical lines and earthing connections	14

1. General

Congratulations on purchasing the product from TEKA.

Our engineers ensure that our devices reflect the state of the art through continuous development. Nevertheless, misuse or misconduct can endanger your safety. Please observe the following for a successful use of the device:

	<p>Only authorised and instructed personnel can carry out transport, operation, maintenance and repair of the device. The operator must ensure that the operating personnel take note of these instructions.</p> <p>Please read these instructions before operating the device, and observe the safety precautions to avoid injury!</p> <p>Store this manual in a safe place! These instructions are to be regarded as a component of the product!</p> <p>Adhere to all product notes!</p> <p>Modifications or conversions that the operator carries out at the device without the consent of the manufacturer, can lead to new safety hazards or to the loss of warranty claims.</p> <p>Observe the manufacturer's instructions. Contact the manufacturer in case of any uncertainty: Tel: +49 2541-84841-0 E-mail: info@teka.eu</p>
---	---

2. Description of the system elements

2.1. Illustration of the system elements

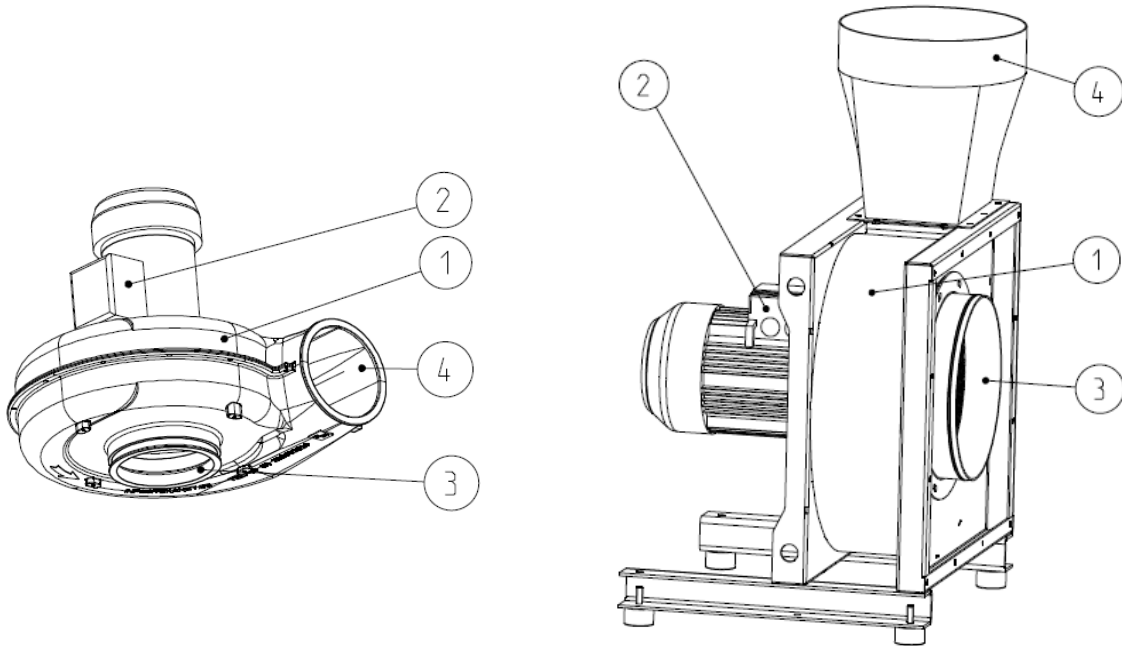

Z.Nr. 15053701 / 12183704

Pos.1	Fan housing	Pos.3	Suction nozzle
Pos.2	Connection for mains cable	Pos.4	Exhaust air nozzle

2.2. Intended use

The device is intended for commercial use. If the device is made publicly accessible, it must never be operated unsupervised by authorized personnel, authorized by the operator.

The fan is used as a source of suction for the delivery of air, e.g. for ventilating or venting a room.

The fan can also be used for point-like suction of welding smoke. For this purpose, the fan can be equipped with a hose line or pipeline or suitable extraction devices for the application.

	WARNING
	<p>Improper use can damage parts and be a danger to life and limb! The device must not be used for the extraction of oil-laden welding fume, explosive dust and gases, hybrid mixtures, glowing or burning substances, gases, water, etc. The device must not be operated in explosive zones.</p> <hr/> <p>Dangers arising from fire. If the sucked medium is combustible fume or dust, the operator must determine beforehand which fire protection measures are to be taken.</p>

2.3. Residual risk

	CAUTION
<p>Danger due to possible hazardous materials in the exhaust air flow. Because the unit does not monitor the quality of the air in the exhaust air flow, we recommend that you always guide the exhaust air flow exiting our unit to areas (e.g. to the outside into the open air) in which there is no danger to any living being. To do this, it is necessary to fit a suitable exhaust air line at the filter unit.</p>	

3. Safety instructions

3.1. Definition of the hazard symbols

The device is constructed according to the state of the art and the recognised safety regulations. Nevertheless, during use threats to life and limb of the user or other persons may arise. The impairment of the machine or other property are also possible. In these instructions we warn by using corresponding indications.

	WARNING WARNING These instructions are made in case of risks that can lead to <u>injury or death</u> .
---	--

	CAUTION CAUTION These instructions are made in case of risks that can lead to <u>injury</u> .
---	---

	NOTICE NOTICE These instructions are made in case of risks that can lead to <u>material damages</u> .
--	---

	Information notes are no hazard warnings; they call attention to useful information.
---	--

3.2. General safety instructions

	WARNING Dangers arising from improper use / unauthorised operations. The operator must ensure that their authorised personnel are familiar with all the safety indications in this manual in advance. The operator is responsible for ensuring that all work is carried out by authorised and qualified personnel. Laymen are allowed to operate the device after having received the necessary instructions. But they are not allowed to carry out any installation, repair or maintenance work. Dangers arising from fire. In case of fire, if possible, switch the unit immediately off or disconnect it from the power supply. Fire extinguishing measures which the operator is obliged to determine beforehand must be initiated immediately.
---	---

	WARNING Dangers arising from electricity. The operator must ensure that electrical plants and equipment are only built, modified and maintained by a qualified electrician or under the direction and supervision of a qualified electrician. Do not work on components if you are not sure that these are disconnected. If necessary, disconnect the device from the electric power supply and secure it against unauthorized restarting.
---	--

4. Storage, transport and installation of the device

	WARNING
	<p>Risk of injury from tilting or unmounted components when stored or transported. The device must be secured against tilting and slipping when it is stored or transported. Do not stand under or next to the floating load. Lift trucks, forklift trucks and transport cranes must have a sufficient minimum load bearing capacity.</p> <hr/> <p>Risk of injury arising from the falling unit at its destination. The unit must be firmly mounted to the destined wall. The wall must be vibration-free and vertical. The operator must check if the wall provides a sufficient bearing capacity. (This only applies if the fan is mounted on the wall.)</p>

	NOTICE
	<p>Damage or functional impairment of the unit due to climatic influences. The unit must be stored in a dry place and protected against moisture during transport. As a matter of principle, the filter unit is not designed to be installed outdoors. In this case contact the manufacturer in order to find out if a caping or a trace heating system are necessary.</p>

5. Commissioning

	WARNING
	<p>Dangers arising from a defective condition of the unit. Make sure that the measures described in this chapter are completed before the commissioning of the unit. All required connections must be attached before turning the unit on. Do not operate the unit if any components are defective, missing or damaged. Check the orderly condition of the unit before switching it on. The position of use of the fan is arbitrary</p>

	NOTICE
	<p>Damaged supply lines. Make sure that the supply lines are protected against damage by forklift trucks and similar events. Protect all supply lines from heat, moisture, oil and sharp edges.</p>

5.1. Connecting the suction line and exhaust air line

For extracting the contaminated air, a suction line must be connected to the suction nozzle (see chapter 2.1).

Depending on the application, the suction pipe must be equipped with extraction elements (suction arm, extraction hose, round duct grille, etc.). When using a capture element with an extractor cowl, the extractor cowl must follow the weld seam, if possible by using the movement of the welding fume caused by thermal influences.

CAUTION You have to make sure that connections between the workpiece and the suction hood (and in general between the workpiece and the filter unit) are avoided in order to prevent the welding current from flowing back to the welding machine via the protective conductor of the filter unit.

If the air shall be directly sucked off by an upstream machine, the suction line must be connected to the capture opening of the upstream machine.

The exhaust air pipe must be attached to the exhaust nozzle (see chapter 2.1).

	WARNING
Danger to life when reaching the fan impeller. The required exhaust air pipe must be attached before the commissioning. This also applies to the suction line. The fan may only be operated without suction line or exhaust air line if the suction nozzle and exhaust air nozzle are secured by a grille.	

5.2. Electrical connection

	WARNING
Risk of electric shock. Electrical plants and equipment may only be built, modified and maintained by a qualified electrician or under the direction and supervision of a qualified electrician. Do not work on live electrical components and elements if you are not sure that these are indeed disconnected. If necessary, disconnect the device from the mains. The operator is responsible for a potential-free balance of the equipment. If the unit is equipped with a frequency converter, then it may only be operated on networks with an AC/DC sensitive RCCB. The AC/DC sensitive residual current circuit breaker (type B) must tolerate at least a permissible residual current of 100mA. For frequency converter operation, the cross section of the protective conductor <ul style="list-style-type: none">• must be at least 10mm²,• and must be at least equal to the size of the operator side outer conductor cross-section.	

	NOTICE
Electric malfunction possible in cause of an incorrect power supply. Pay attention to the admissible supply voltage. Please observe the specifications on the type plate.	

- Connect the mains cable (see chapter 2.1) to the power supply.

6. Maintenance

In accordance with national regulations, the operator is obliged to carry out repeat and functional tests. Unless otherwise specified by national regulations, we recommend regular visual inspections and functional tests of the device as described in the chapter "Maintenance intervals".



You find the chapter "Maintenance intervals" at the end of the document. The general maintenance (visual inspection, etc.) is also explained there.



WARNING

Work on the open system entails the risk of electrical shock or accidental restart the system. Both pose a danger to life and limb.

When cleaning and servicing equipment during the replacement of parts or when changing to another function, set the device to maintenance condition first (see chapter "Reset to maintenance state").

A recommissioning of the device must only occur if it is ensured that the device is functionally equivalent to the original state.

Dangers to life and limb when non-original spare parts are used

Only original TEKA spare parts must be used.

6.1. Reset to maintenance state

- Switch off the unit. Secure the unit against unauthorized restarting during maintenance.
- After completion of all maintenance work the unit can be switched on again.

7. Dismantling / Disposal

Only authorised personnel may disassemble the machine.



WARNING

Dangers arising from electricity.

Before the dismantling of the machine it has to be disconnected from the power supply and all supply lines.

8. Diagnostics and troubleshooting

A list of possible system errors is provided in the table.

A recommissioning of the device must only occur if it is ensured that the system is functionally equivalent to the original state. Repairs may only be carried out by TEKA personnel or, after consultation with TEKA GmbH, by the personnel authorised by the operator.

Adhere to the instructions in the chapter "Safety instructions" and "Maintenance" when carrying out any repairs. If in doubt, contact our TEKA service department:

Tel: +49 2541-84841-0

E-mail: info@teka.eu

Fault	Cause	Removal
Suction power too low (smoke hardly extracted).	The motor rotates in the wrong direction.	The rotating field of mains connection point must be changed.
	Suction line contracted.	Check and fix.
	Exhaust line contracted.	Check and fix.
	Maybe throttle valves are used in the suction line.	Adjust throttle valves.

9. Technical data

Supply voltage	V	230 / 400 / 500										
Frequency	Hz	50										
Type of current	Ph	230 V = 1 400 + 500 V = 3										
Engine power	kW	<table border="1"> <tr> <td>0,5</td> <td>0,75</td> <td>1,1</td> <td>1,5</td> <td>2,2</td> <td>3,0</td> <td>4,0</td> <td>5,5</td> <td>7,5</td> <td>11</td> </tr> </table>	0,5	0,75	1,1	1,5	2,2	3,0	4,0	5,5	7,5	11
0,5	0,75	1,1	1,5	2,2	3,0	4,0	5,5	7,5	11			
Air flow volume max.	m³/h	<table border="1"> <tr> <td>1000</td> <td>2000</td> <td>2500</td> <td>3000</td> <td>3500</td> <td>4000</td> <td>5000</td> <td>6000</td> <td>7500</td> <td>10000</td> </tr> </table>	1000	2000	2500	3000	3500	4000	5000	6000	7500	10000
1000	2000	2500	3000	3500	4000	5000	6000	7500	10000			
Protection class		IP54										
ISO class		F										
Allowed ambient temperature	°C	+5 to +35 (<i>during operations</i>) -10 to +40 (<i>during transport and storage</i>)										
Max. temperature of polluted air at the capture point	°C	+50										
Allowed max. humidity	%	70										

10. EC declaration of conformity

according to the Machinery Directive 2006/42/EG, Annex II, 1 A

TEKA Absaug- und Entsorgungstechnologie GmbH

Millenkamp 9, D-48653 Coesfeld

Tel.: +49 2541-84841-0

E-Mail: info@teka.eu

Internet: www.teka.eu

Designation of the device: TEKA fan 0,55 - 11,0 kW

We hereby declare under our sole responsibility that the product mentioned above, from the serial number A22600010011001 resp. P57300010011001 on, conforms to the following directives:

Machinery Directive: 2006/42/EG

Electromagnetic Compatibility: 2014/30/EU

RoHS directive: 2011/65/EU

This declaration will become void if the device is exposed to modifications that are not approved by the manufacturer in written form.

Authorized representative for the technical documentation:

TEKA Absaug- und Entsorgungstechnologie GmbH, Millenkamp 9, D-48653 Coesfeld

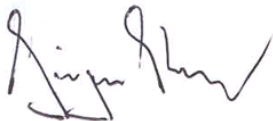

(Jürgen Kemper, managing director)

Coesfeld, 3rd January 2023

11. Maintenance intervals

11.1. General maintenance

The described maintenances are independent from the demands of the system operations.

The operator is obliged to carry out repeated inspections and functional tests according to national regulations. If not otherwise covered by national regulations, the described maintenance intervals must be respected.

Maintenance work must always be documented by means of a protocol.

Maintenance work	Chapter	Maintenance interval
Visual inspection of the device	11.1.1	weekly
Electrical test of the electrical lines and earthing connections	11.1.2	annually

11.1.1. Visual inspection of the device

Visual inspection: Observation that there are no visible safety-related defects.

	WARNING
	Danger arising from the ready to operate condition of the device. Follow the procedure as described in the chapter "Set to maintenance state".

The following steps must be carried out in the course of the visual inspection:

- Check if all required pipeline elements, cable connections and hoses are connected to the filter unit
- Ensure that all parts are firmly connected.
- Check all connection points of the filter unit for escaping dust.
- Check all metal parts for corrosion or damages / changes of the coating.
- If the fan is used to extract contaminated air (such as welding fumes), clean the inside of the fan. Otherwise, a dirty impeller may cause imbalance and engine damage.

11.1.2. Electrical test of the electrical lines and earthing connections

	WARNING
Danger arising from electricity. The operator is responsible for ensuring that all work on electric components is carried out by authorised and qualified personnel.	

The device is subject to regular electrical checks by the operator of the device, and are subject to national standards of the different countries.

The here recommended maintenance interval complies with the in Germany applying "Regulation 3 of the German Social Accident Insurance - Electrical plants and equipment" (formerly known as BGV-A3).

The check must only be carried out by a qualified electrician or a person trained in electrics using suitable measuring and test devices. The scope of testing and the methods must be in line with the respective national standard. All contacts in the control cabinet must be checked for tight fit, and must be readjusted if necessary.